

JUMO GmbH & Co. KG
 Delivery address: Mackenrodtstraße 14,
 36039 Fulda, Germany
 Postal address: 36035 Fulda, Germany
 Phone: +49 661 6003-0
 Fax: +49 661 6003-607
 E-mail: mail@jumo.net
 Internet: www.jumo.net

JUMO Instrument Co. Ltd.
 JUMO House
 Temple Bank, Riverway
 Harlow, Essex CM20 2DY, UK
 Phone: +44 1279 635533
 Fax: +44 1279 635262
 E-mail: sales@jumo.co.uk
 Internet: www.jumo.co.uk

JUMO Process Control, Inc.
 6733 Myers Road
 East Syracuse, NY 13057, USA
 Phone: 315-437-5866
 1-800-554-5866
 Fax: 315-437-5860
 E-mail: info.us@jumo.net
 Internet: www.jumousa.com



JUMO DICON 401/501 Universal profile controllers/generators

Brief description

The series of universal, freely configurable profile controllers/generators is available in the formats 96mm x 96mm and 96mm x 48mm (portrait and landscape format).

The instruments feature two 4-digit 7-segment displays, five or eight LEDs for indicating the switching status and operating modes, an 8-digit matrix display, as well as six keys for operation and configuration.

The user has flexibility in assigning the slots of the profile controller according to the block structure.

10 profile programs with up to 100 segments can be programmed; a total of 100 segments is available.

Additional functions include self-optimisation, parameter set switching, a real-time clock, up to 8 limit comparators and a maximum of eight operating contacts.

Linearisations for conventional transducers are stored in the memory; furthermore, a customized linearisation table can be programmed.

The profile controllers can be adapted to a variety of tasks with the aid of a maths module. The instruments can be integrated into a data network via a serial interface, or they can be expanded through an external relay module.

A setup program with a program editor is available for easy configuration from a PC.

The electrical connection is at the rear by screw terminals.



JUMO DICON 501
 Type 703580/0...



JUMO DICON 401
 Type 703585/1...



JUMO DICON 401
 Type 703585/2...

Block structure

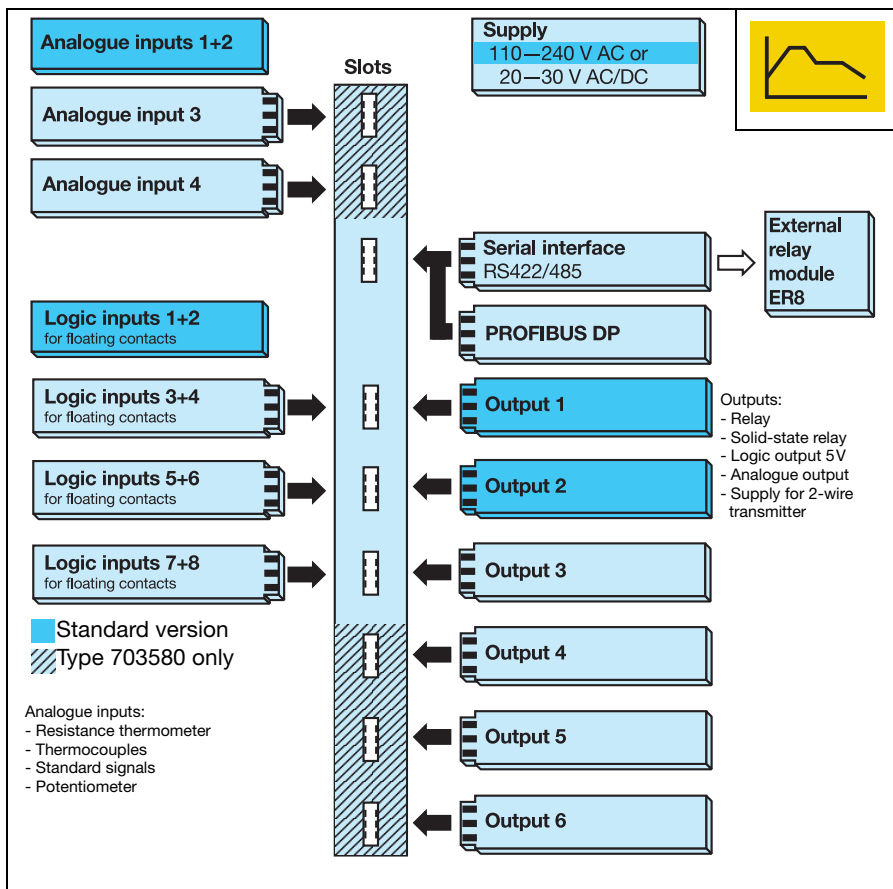

Features

- Switchable displays
- Text or bar graph display
- 8 limit comparators
- 2 parameter sets
- Maths and logic module
- 8 operating contacts
- Real-time clock
- Setup program with JUMO start-up software and program editor for Windows® NT4.0/2000/XP/Vista/7 (32/64 bit)

Approvals/approval marks (see Technical data)



Profile controller

10 profile programs with up to 100 segments can be programmed. A total of 100 segments is programmable. In addition, eight operating contacts can be assigned to the corresponding program segments.

A profile program can be started manually from the keys (on the instrument or externally), or by programming the start conditions. When programming the start conditions, the time can be set either by selecting a start delay, or by programming a weekday and time. Furthermore, it is possible to program a weekly profile with 10 entries via the setup program.

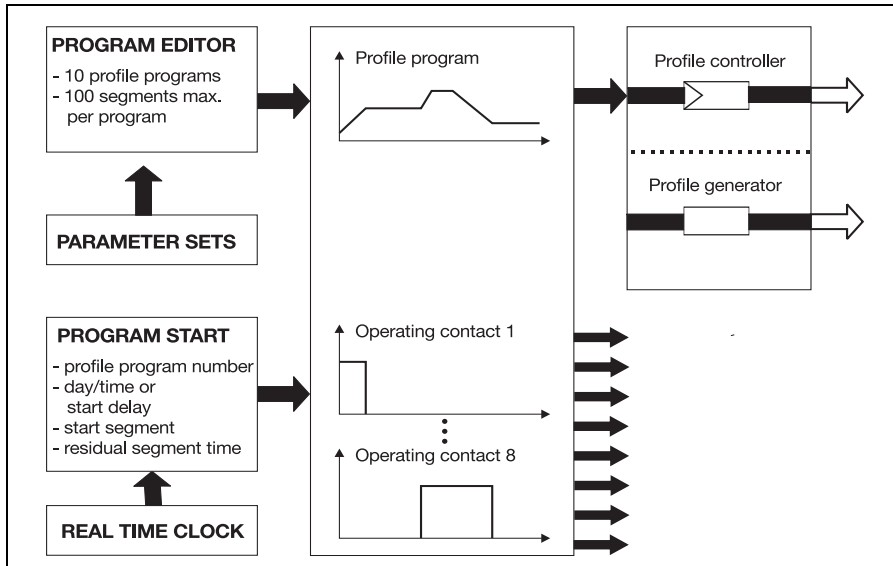

Profile programs consist of a series of segments with definable segment setpoints. The individual segment setpoints are connected either by ramps or by step functions. At each segment, the status of the eight operating contacts can be modified.

In addition, each segment can have assigned to it one of the two programmable parameter sets, as well as an upper and a lower limit (tolerance band) for monitoring the process value.

Continuous loops can be set up through programmable repeat cycles. Segments are defined by the segment setpoint and segment time, or the ramp slope (gradient). Through the integral program editor it is possible to create segments from the keys, as well as to edit, copy or delete them.

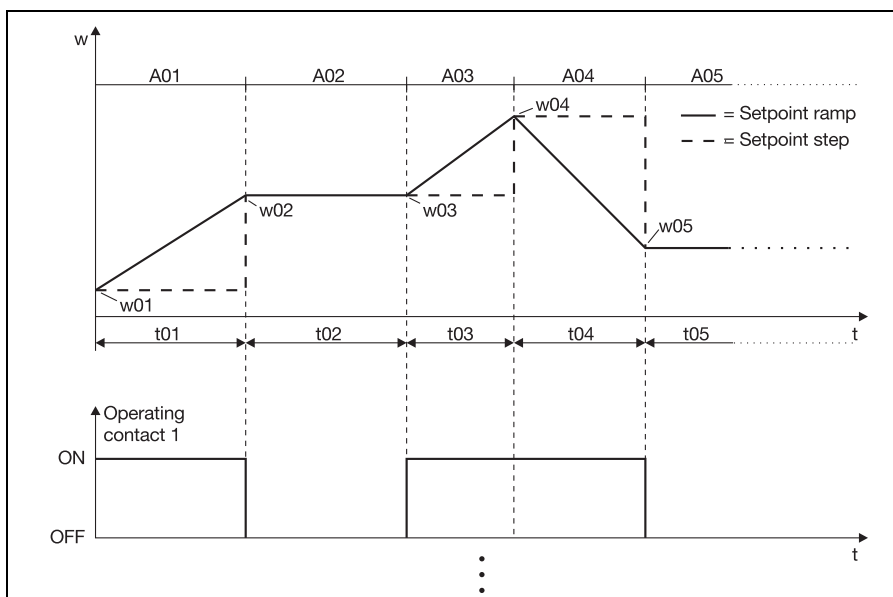

Self-optimisation

The standard specification includes an auto-tuning facility which permits the user to adjust the controller to the process without any knowledge of control engineering.

Customized linearisation

In addition to the linearisation for the usual transducers, a customer-specific linearisation can be created.

Programming is carried out via the setup program, in the form of a table of values.

Maths and logic module (option)

The maths module permits integrating e. g. setpoints, control outputs and the measured values of the analogue inputs into a mathematical formula.

The logic module can be used to create logic links between logic inputs, limit comparators and operating contacts, for example.

Two formulae can be entered via the setup program for each of the two modules. The results of the calculation can then be produced via the outputs or used for internal purposes.

There is an additional possibility of implementing difference, ratio and humidity control through established standard formulae.

Configurable displays

Any process variable can be visualised on the 7-segment displays and the dot-matrix display.

It is possible to switch between two displays either from the keys, or automatically after an adjustable interval.

Setup program (accessory)

The setup program for instrument configuration is available in English, German and French. A PC can be used to create and edit data sets, transfer them to the controller, or read them out of the instrument. The data sets are stored and managed.

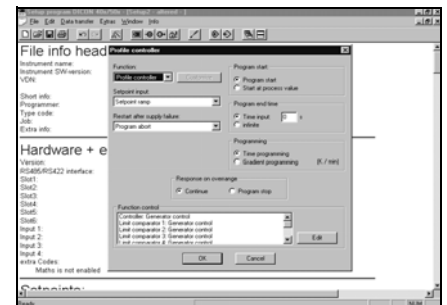

With the aid of the program editor, which is integrated into the setup program, profile programs can easily be created, edited and transferred.

JUMO Start-up software

The JUMO start-up software is an integral part of the setup program and is available for conveniently adapting the controller to the process.

Different process variables (e. g. setpoint, process value, control deviation, signals from the controller outputs) can be displayed graphically. The controller parameters can be altered and transferred to the controller via the setup or RS422/485 interfaces.

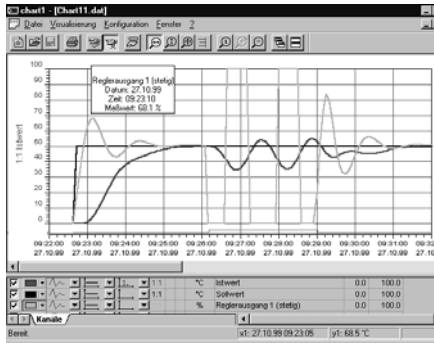

Text display

Customer texts can be assigned to the functions of the logic inputs, the limit comparators, the logic outputs of the logic module and the operating contacts. It is also possible to designate profile program names.

Depending on the status of the function or the configuration of the displays, a programmed text (8 characters max.) is shown on the matrix display.

The customer texts and the program names can only be set up with the aid of the setup program.

PROFIBUS-DP (option)

The controller can be integrated into a fieldbus system to the PROFIBUS-DP standard, via the PROFIBUS-DP interface. This PROFIBUS variant has been designed specifically for the communication between automation systems and decentralised peripheral instruments at the field level, and is speed-optimised.

The data are transmitted serially in accordance with the RS485 standard.

Using the project design tool included in the delivery (GSD-generator; GSD = instrument master data), a standardised GSD file is created that serves to integrate the controller into the fieldbus system, through selection of the controller data.

RS422/RS485 interface (option)

The serial interface is available for communication with higher-level systems. Modbus/Jbus are used as transmission protocols.

External module ER8/EL8 (accessory)

With the external module ER8 or EL8 (standard DIN rail mounting) the controller can be expanded by eight relay or logic outputs. The module is controlled via the RS422/RS485 interface. For configuration, the setup program is necessary.

Functions of the logic inputs

- Programming inhibit
- Profile program start/stop/cancel
- Profile program selection
- Fast forward
- Segment change
- Start/cancel self-optimisation
- Setpoint switching
- Process value switching
- Parameter set switching
- Key/level inhibit
- Text display
- All displays off
- Auto/manual changeover

Functions of the outputs

- Analogue input variables
- Mathematics
- Process value
- Setpoint
- Control deviation
- Control output
- Controller outputs
- Limit comparators
- Operating contacts
- Logic inputs
- Logic
- Profile-program end signal
- Tolerance band signal
- Manual mode signal

Operation, parameterization, configuration

Operation, as well as setting the controller parameters and configuration, are arranged at different levels.

Operating level

Different process variables (measurements of the analogue inputs, program times...) can be indicated here.

Profile program start

The conditions for the start of the program are defined here.

Profile program editor

Here, the programs are set up from the keys and edited.

Parameter level

The controller parameters are set here.

Configuration level 1

The basic functions of the instrument, such as restart, profile program end time, are set at this level.

Configuration level 2

The hardware and software codes which correspond to the controller version are indicated here.

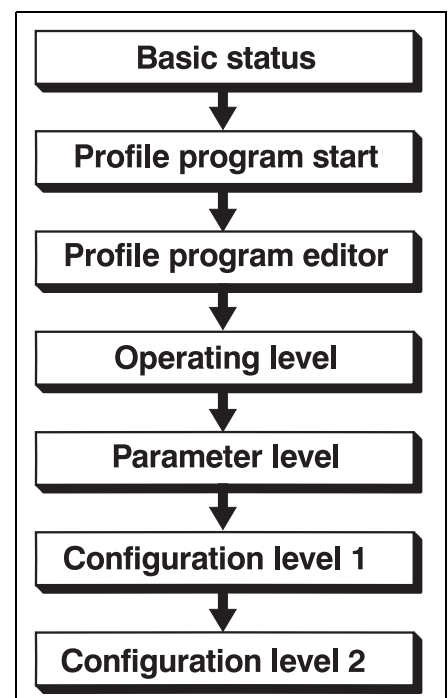

Displays and controls

<p>(1) configurable 7-segment display 4 digits, red</p> <table border="1"> <thead> <tr> <th>Type</th> <th>Height</th> </tr> </thead> <tbody> <tr> <td>703580</td> <td>13mm</td> </tr> <tr> <td>703585</td> <td>10mm</td> </tr> </tbody> </table> <p>factory-set: process value</p>	Type	Height	703580	13mm	703585	10mm	<p>(4) Setup interface (for position, see dimensional drawings)</p>
Type	Height						
703580	13mm						
703585	10mm						
<p>(2) configurable 7-segment display 4 digits, green</p> <table border="1"> <thead> <tr> <th>Type</th> <th>Height</th> </tr> </thead> <tbody> <tr> <td>703580</td> <td>10mm</td> </tr> <tr> <td>703585</td> <td>7mm</td> </tr> </tbody> </table> <p>factory-set: setpoint</p>	Type	Height	703580	10mm	703585	7mm	<p>(5) Status indication 6 (3) yellow LEDs for the switching status indication of the outputs 2 green LEDs to display the “Manual” and “Automatic” operating modes.</p>
Type	Height						
703580	10mm						
703585	7mm						
<p>(3) configurable dot-matrix display 8 digits, green factory-set: program status</p>	<p>(6) Keys</p>						

Isolation

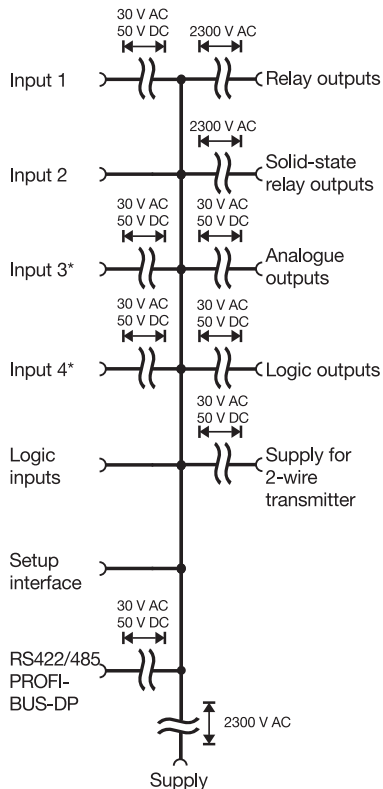

*Type 703580 only

Profile controller (extract from configuration level 1)

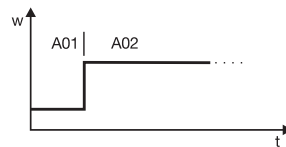
Parameters	Selection/Value range	Description
Function	Profile controller Profile generator	The instrument can be operated as profile controller or profile generator.
Restart	Profile program stop Continue Hold Continue at deviation <x% Continue at process value	Response of the controller on a supply failure.
Profile program start	Start at profile program start Start at process value	Start conditions for the start of profile programs. Program start: Program starts with the programmed setpoint of the first segment (A01) Start at PV: The present process value is accepted as the first setpoint; the program starts at the corresponding segment
Setpoint input	Setpoint ramp Setpoint step	Setpoint ramp:  Setpoint step: 
Time/gradient	Time Gradient	Types of program entry. Time: segment setpoint/segment time Gradient: segment setpoint/gradient
Function control	Generator control Operating contact 1 ... Operating contact 8	Controller and limit comparators 1 – 8 can be switched off individually during the program run. Generator control: Controller or limit comparators are active during the program run Operating contact 1–8: Controller or limit comparators are only active, when the corresponding operating contact is in the “ON” status
Process value deviation	0 – 100 digit	Parameter for “Continue at deviation < x%”
Profile program end time	-1 – 9999 sec	Duration of the program end signal (for outputs); -1= infinite

Parameter level

The table lists all the parameters and their meaning. Depending on the controller type, certain parameters are irrelevant or not applicable. Two parameter sets can be stored for specific applications.

Parameters	Display	Value range	factory-set	Meaning
Controller structure	Structure 1	P, I, PD, PI, PID	PID	Structure 2 refers to the second output in the case of a double-setpoint controller
	Structure 2	P, I, PD, PI, PID	PID	
Proportional band	Xp1	0 – 9999 digit	0 digit	Size of the proportional band At Xp =0 the controller structure is not effective!
	Xp2	0 – 9999 digit	0 digit	
Derivative time	Tv1	0 – 9999 sec	80 sec	Influences the differential component of the controller output signal
	Tv2	0 – 9999 sec	80 sec	
Reset time	Tn1	0 – 9999 sec	350 sec	Influences the integral component of the controller output signal
	Tn2	0 – 9999 sec	350 sec	
Switching cycle time	Cy1	0 – 9999 sec	20 sec	For a switching output, the cycle time should be selected so that the energy supply to the process is virtually continuous while, at the same time, not overloading the switching devices.
	Cy2	0 – 9999 sec	20 sec	
Contact spacing	Xsh	0 – 9999 sec	0 digit	Spacing between the two control contacts for double-setpoint controllers, modulating controllers and proportional controllers with integral actuator driver
Switching differential	Xd1	0 – 999 digit	1 digit	Differential for switching controllers for Xp = 0
	Xd2	0 – 999 digit	1 digit	
Stroke time	TT	5 – 3000 sec	60 sec	Utilised stroke time of the control valve on modulating controllers and proportional controllers with integral actuator driver
Working point	Y0	-100 to +100%	0%	Output on P and PD controllers (y = Y0 at x = w).
Output limiting	Y1	0 – 100%	100%	Maximum output limit
	Y2	-100 to +100 %	-100%	Minimum output limit
Minimum relay ON time	Tk1	0 – 60 sec	0 sec	Limitation of the switching frequency on switching outputs
	Tk2	0 – 60 sec	0 sec	

Technical data

Thermocouple input

Designation	Range ¹	Meas. accuracy	Ambient temperature error
Fe-Con L	-200 — +900°C	≤0.25%	100 ppm per °C
Fe-Con J EN 60 584	-200 — +1200°C	≤0.25%	100 ppm per °C
Cu-Con U	-200 — +600°C	≤0.25%	100 ppm per °C
Cu-Con T EN 60 584	-200 — +400°C	≤0.25%	100 ppm per °C
NiCr-Ni K EN 60 584	-200 — +1372°C	≤0.25%	100 ppm per °C
NiCr-Con E EN 60 584	-200 — +910°C	≤0.25%	100 ppm per °C
NiCrSi-NiSi N EN 60 584	-100 — +1300°C	≤0.25%	100 ppm per °C
Pt10Rh-Pt S EN 60 584	-50 — +1768°C	≤0.25%	100 ppm per °C
Pt13Rh-Pt R EN 60 584	-50 — +1768°C	≤0.25%	100 ppm per °C
Pt30Rh-Pt6Rh B EN 60 584	0 — 1820°C	≤0.25% ²	100 ppm per °C
W5Re-W26Re	0 — 2320°C	≤0.25%	100 ppm per °C
W3Re-W25Re	0 — 2400°C	≤0.25%	100 ppm per °C
Cold junction	Pt100 internal, external or constant		

1. The specifications refer to an ambient temperature of 20°C.

2. within range 300 – 1820°C

Resistance thermometer input

Designation	Connection type	Range	Meas. accuracy	Ambient temperature error
Pt100 EN 60 751	2-wire/3-wire	-200 +850°C	≤0.05%	50 ppm per °C
Pt 50,500, 1000 EN 60 751	2-wire/3-wire	-200 +850°C	≤0.1%	50 ppm per °C
KTY21-6	2-wire	-50 +150°C	≤1.0%	50 ppm per °C
Cu50	2-wire/3-wire	-50 +200°C	≤0.1%	50 ppm per °C
Ni100 DIN 43 760	2-wire/3-wire	-60 +250°C	≤0.05%	50 ppm per °C
PTK9	2-wire	lithium-chloride sensor		
Sensor lead resistance	max. 30Ω per conductor in 2-/3-wire circuit			
Measuring current	250µA			
Lead compensation	not required for 3-wire circuit. For 2-wire circuit, lead compensation can be provided in the software by a process value correction.			

Standard signal input

Designation	Range	Meas. accuracy	Ambient temperature error
Voltage	0 — 10V, input resistance $R_E > 100k\Omega$	≤0.05%	100 ppm per °C
	-10 to +10V, input resistance $R_E > 100k\Omega$	≤0.05%	100 ppm per °C
	1 to + 1V, input resistance $R_E > 100k\Omega$	≤0.05%	100 ppm per °C
	0 to + 1V, input resistance $R_E > 100k\Omega$	≤0.05%	100 ppm per °C
	0 — 100mV, input resistance $R_E > 100k\Omega$	≤0.05%	100 ppm per °C
	-100 to +100mV, input resistance $R_E > 100k\Omega$	≤0.05%	100 ppm per °C
Current	4 — 20mA, voltage drop ≤ 1V	≤0.05%	100 ppm per °C
	0 — 20mA, voltage drop ≤ 1V	≤0.05%	100 ppm per °C
Potentiometer	100Ω min., 10kΩ max.		

Measurement circuit monitoring¹

Transducer	Over/underrange	Probe/lead short-circuit	Probe/lead break
Thermocouple	•	-	•
Resistance thermometer	•	•	•
Voltage 2 — 10V 0 — 10V	•	•	•
	•	-	-
Current 4 — 20mA 0 — 20mA	•	•	•
	•	-	-

• = recognised -- = not recognised

1. In the event of an error, the outputs move to defined states (0%, 100%, -100% configurable).

■ Standard version

Outputs

Relay contact rating contact life	changeover contact 3A at 250VAC resistive load 150 000 operations at rated load		
Logic current limiting	0/5V 20mA	or	0/22V 30mA
Solid-state relay contact rating	1A at 230V		
Voltage output signals load resistance	-10 to +10V/0 – 10V/2 – 10V R _{load} 500Ω min.		
Current output signals load resistance	-20 to +20mA/0 – 20mA/4 – 20mA R _{load} 450Ω max.		
Supply for 2-wire transmitter voltage current	22V 30mA		

Controller

Controller type	single setpoint-controller, double setpoint-controller, modulating controller, proportional controller, proportional controller with integral actuator driver
Controller structures	P/PD/PI/PID
A/D converter	resolution better than 15 bit
Sampling time	210msec

Electrical data

Supply (switched mode power supply)	110 – 240V AC +10/-15% 48 – 63Hz 20 – 30V AC/DC, 48 – 63Hz
Test voltages (type test)	to EN 61010, Part 1 overvoltage category II, pollution degree 2
Power consumption	10 VA max. for Type 703580 7 VA max. for Type 703585
Data backup	EEPROM
Electrical connection	At the rear via screw terminals, conductor cross-section up to 2.5mm ² and core-end sleeve (length: 10mm)
Electromagnetic compatibility interference emission interference immunity	EN 61326-1 Class A - only for industrial use - to industrial requirements
Safety standards	to EN 60730-1 for Type 703580 to EN 61010-1 for Type 703585

Housing

Housing type	plastic housing for panel mounting (indoor use) acc. to IEC 61554		
Dimensions in mm (for Type)	703585/1...	703585/2...	703580/0...
Bezel	48 x 96 (portrait)	96 x 48 (landscape)	96 x 96
Depth behind panel	130	130	130
Panel cut-out	45 ^{+0.6} x 92 ^{+0.8}	92 ^{+0.8} x 45 ^{+0.6}	92 ^{+0.8} x 92 ^{+0.8}
Ambient/storage temperature range	-5 to 50 °C / -40 to +70 °C		
Climatic conditions	rel. humidity, not exceeding 90% annual mean, no condensation		
Site altitude	up to 2000 m above sea level		
Operating position	any		
Protection	acc. to EN 60529, front IP65, rear IP20		
Weight (fully fitted)	approx. 420g	approx. 420g	approx. 730g

■ Standard version

Approvals/approval marks

Approval mark	Testing agency	Certificates/certification numbers	Test basis	valid for
DIN	Deutsche Industrie Norm	Registernummer TR1117	DIN EN 14597	DICON 501
GL - Hardware GL - Software	Germanischer Lloyd	Certificate No. 15 694-00 HH	GL-Baumusterprüfung Kategorie C, EMC1	DICON 501
c UL us	Underwriters Laboratories	E 201387	UL 61010-1 CAN/CSA-C22.2 No. 61010-1	DICON 401/501

Connection diagrams

Type 703580

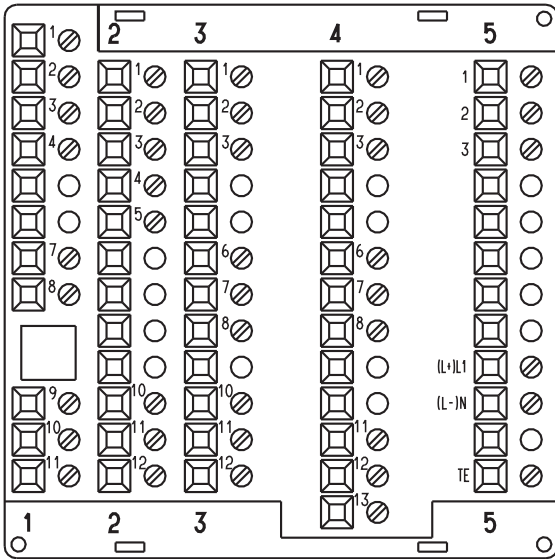

Interface

PROFIBUS DP

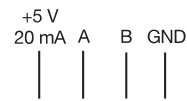

RS485/ER8

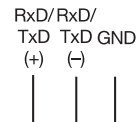

RS422

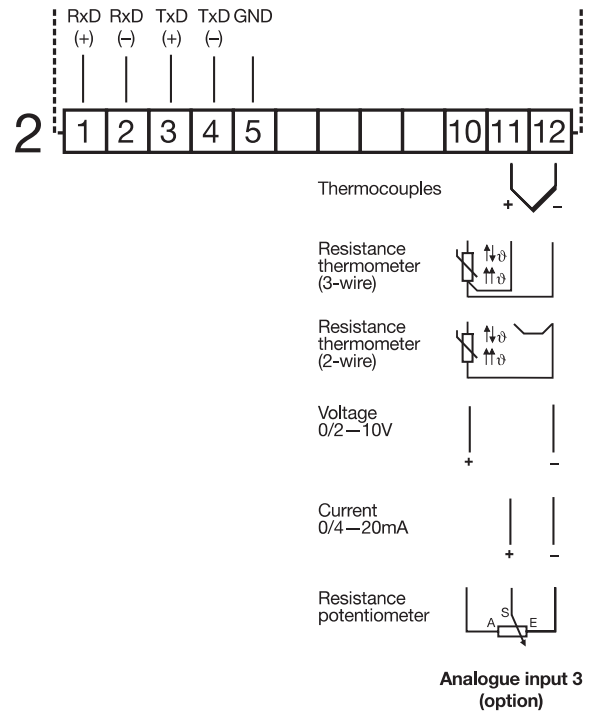
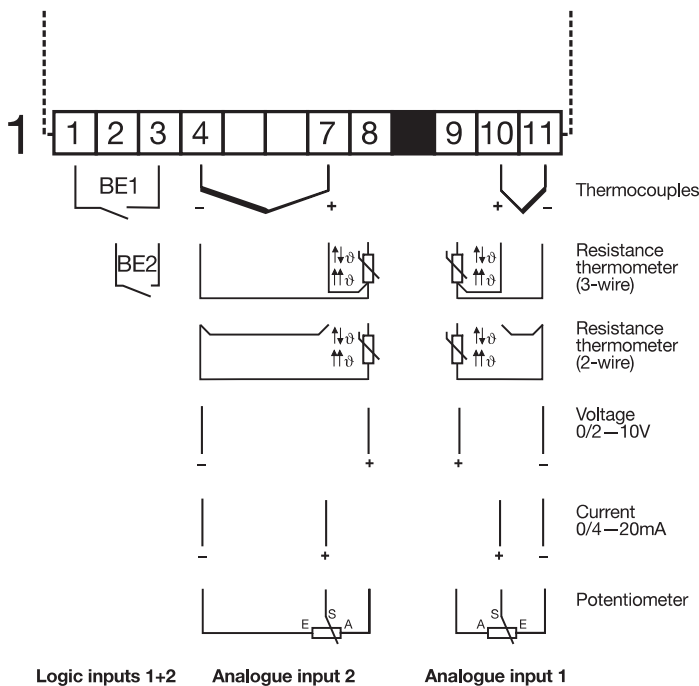

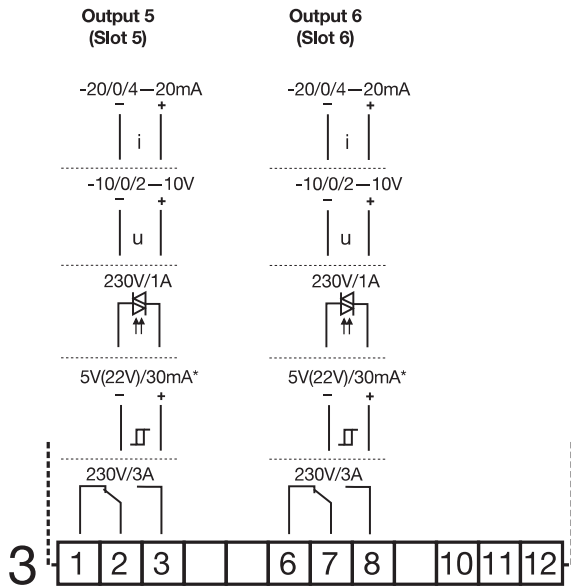

* Supply for 2-wire transmitter (22V)



Analogue input 4 (option)

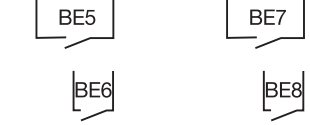
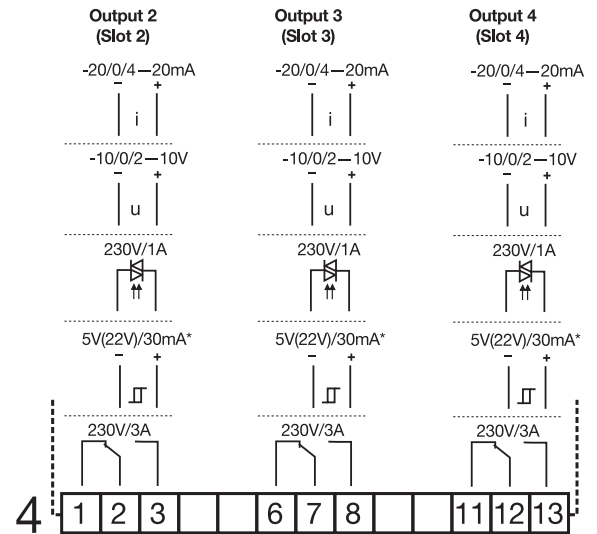

Logic inputs 5+6 (Slot 2)

Logic inputs 7+8 (Slot 3)

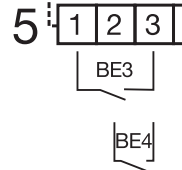
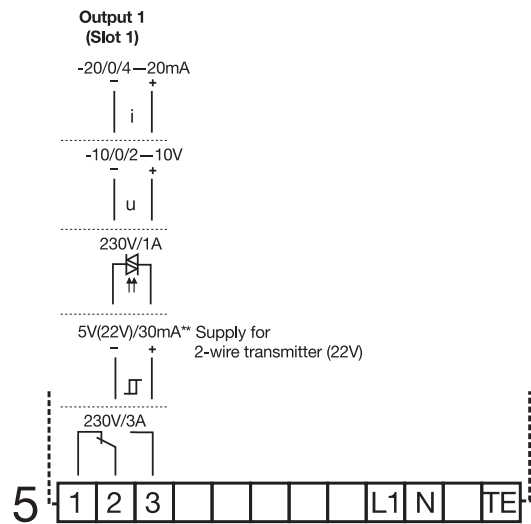

Logic inputs 3+4 (Slot 1)

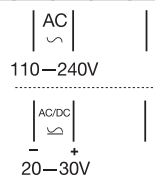

Mains supply

Type 703585/1... (portrait format) and Type 703585/2... (landscape format)

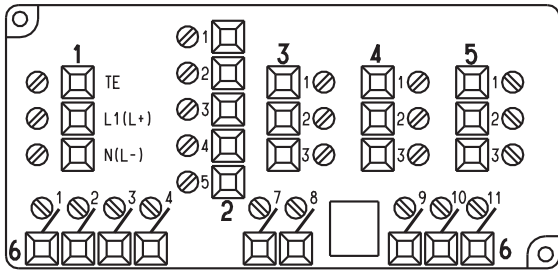

Interface

PROFIBUS DP



RS485/ER8

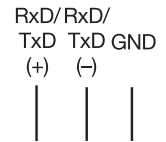

RS422

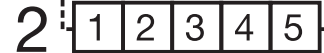
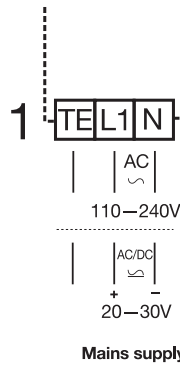
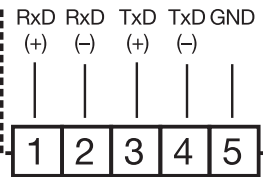

Output 3 (Slot 3)

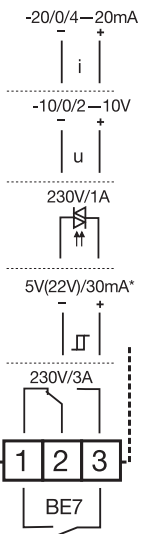

Output 2 (Slot 2)

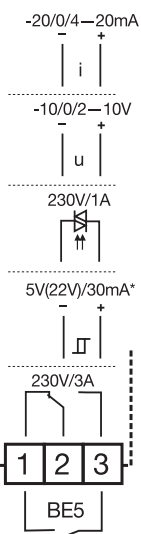

Output 1 (Slot 1)

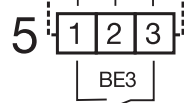
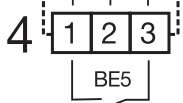
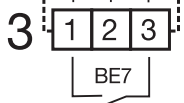
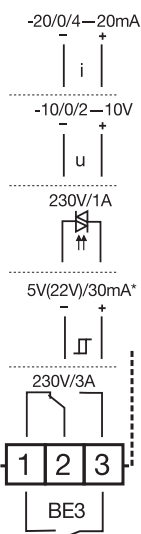

Logic inputs 7+8 (Slot 3)

Logic inputs 5+6 (Slot 2)

Logic inputs 3+4 (Slot 1)

* Supply for 2-wire transmitter (22V)

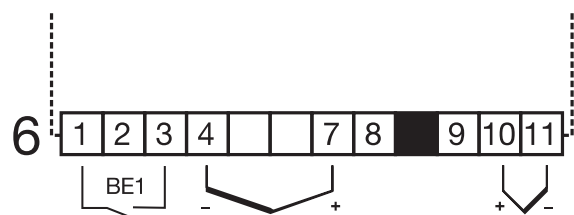

Thermocouples

Resistance thermometer (3-wire)

Resistance thermometer (2-wire)

Voltage 0/2-10V

Current 0/4-20mA

Potentiometer

Logic inputs 1+2

Analogue input 2

Analogue input 1

Dimensions

Type 703580/0...

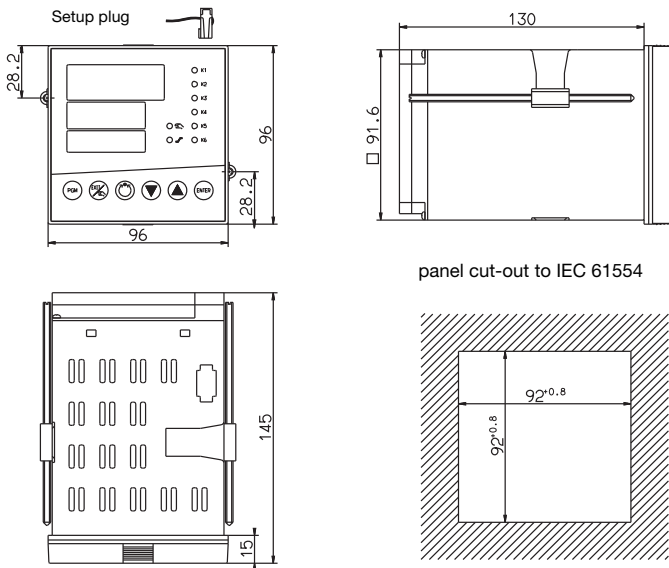

Type 703585/1... (portrait format)

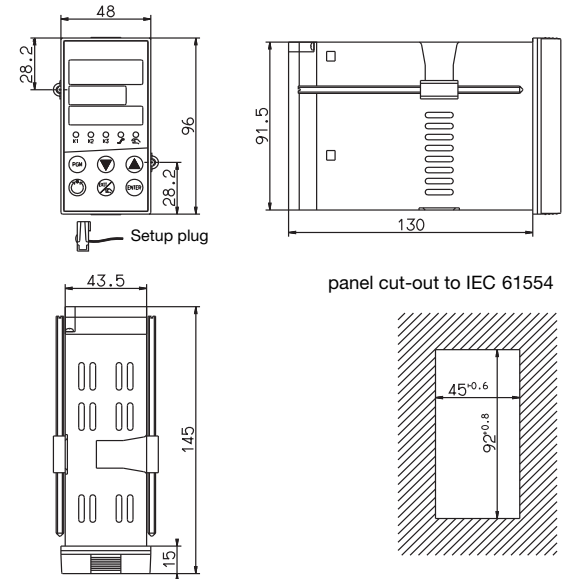

Type 703585/2... (landscape format)

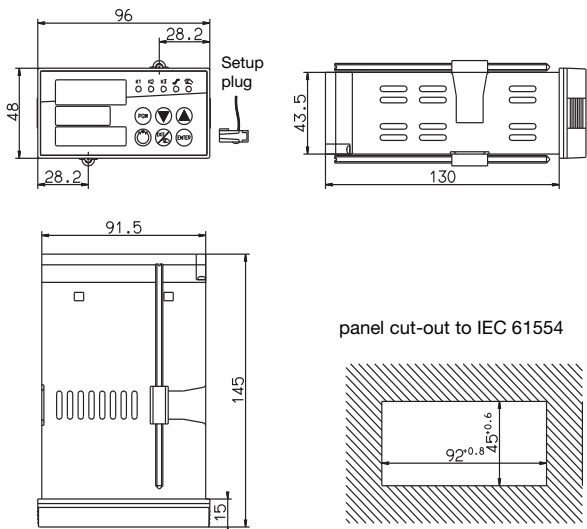

Edge-to-edge mounting		
Minimum distances of panel cut-outs		
Type	horizontal	vertical
without setup plug:		
703580/0...	11 mm	30 mm
703585/1... (portrait)	11 mm	30 mm
703585/2... (landscape)	30 mm	11 mm
with setup plug:		
703580/0...	11 mm	65 mm
703585/1... (portrait)	11 mm	65 mm
703585/2... (landscape)	65 mm	11 mm

External module ER8/EL8

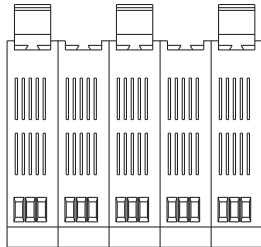
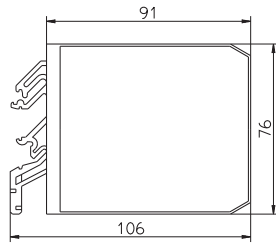
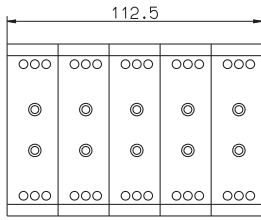

Accessories

External relay module ER8* (3A/230V) Supply 110 — 240V AC Part no. 00405292
External relay module ER8* (3A/230V) Supply 20 — 53V DC/AC Part no. 00405297
External logic module EL8* (0/12V) Supply 110 — 240V AC Part no. 00439131
External logic module EL8* (0/12V) Supply 20 — 53V DC/AC Part no. 00471459
PC interface for setup program with TTL/RS232 converter Part no. 00301315
PC interface for setup program with USB/TTL converter, 2 adapters (socket, pins) Part no. 00456352
Setup program and program editor for Windows® NT4.0/2000/XP/Vista/7 (32/64 bit) Part no. setup program: 00379085 Part no. program editor: 00379547 Hardware requirements: - 512 Mbyte RAM - 50 Mbyte available on hard disk - CD-ROM drive - 1 free serial interface or USB interface

* The RS422/485 interface is required for operating the external module!

Ordering details

Basic type	
703580	JUMO DICON 501: Universal profile controller/profile generator in 96mm x 96mm format
703585	JUMO DICON 401: Universal profile controller/profile generator in 96mm x 48mm and 48mm x 96mm formats

Basic type extensions	
Format	
0	96mm x 96mm
1	48mm x 96mm portrait format
2	96mm x 48mm landscape format
Version	
8	Standard with factory settings
9	Customized programming according to specification
Language of instrument texts	
1	German
2	English
3	French

1.	2.	3.	4.	Analogue input
	0	0		not assigned (analogue inputs 1 + 2 available as standard)
1	1	1	1	Universal input (all listed transducers except voltage ranges -10 to +10V / 0 – 10V / 2 – 10V)
2	2	2	2	Voltage ranges -10 to +10V / 0 – 10V / 2 – 10V

1.	2.	3.	4.	5.	6.	Slot for output/two logic inputs (two logic inputs available as standard)
0	0	0	0	0	0	not assigned
1	1	1	1	1	1	Relay (changeover contact)
2	2	2	2	2	2	Solid-state relay 230V 1A
3	3	3	3	3	3	Logic 0/5V
4	4	4	4	4	4	Logic 0/22V
5	5	5	5	5	5	Analogue output
6	6	6	6	6	6	Supply for 2-wire transmitter
7	7	7				Two logic inputs (logic inputs 3+4, 5+6, 7+8; only possible on slots 1, 2 and 3)

Supply		
2	3	110 – 240V +10/-15% AC 48 – 63Hz
2	5	20 – 30V AC/DC, 48 – 63Hz

Interface		
0	0	not assigned
5	4	RS422/RS485 with MOD/Jbus protocol
6	4	PROFIBUS-DP

Maths and logic module		
0	0	not available
0	3	available

Approvals			
0	0	0	none
0	5	6	EN 14597*
0	6	2	Germanischer Lloyd (GL)*
0	6	3	EN 14597 and GL*
0	6	4	EN 14597 and UL*
0	6	5	GL and UL*
0	6	6	EN 14597, GL and UL*

* for Type 703580 only

703580/

0																	
---	--	--	--	--	--	--	--	--	--	--	--	--	--	--	--	--	--

703585/

			0	0				0	0	0							
--	--	--	---	---	--	--	--	---	---	---	--	--	--	--	--	--	--